



**micromeritics**

**3AFLEX**  
Surface Characterization

# 3AFLEX

Surface and Catalyst Characterization



# HIGH-RESOLUTION, IMPROVED THROUGHPUT MICROPORE ANALYSES

## 3Flex Surface and Catalyst Characterization

A fully automated, three-station instrument designed for a variety of analyses with superior accuracy, resolution, and data reduction:

- Surface area
- Mesopore
- Micropore
- Static Chemisorption
- Dynamic Chemisorption
- Heat of adsorption
- Vapor adsorption



### High Resolution, High-Throughput Physisorption and Chemisorption Instrument

Recognized as the most advanced instrument in the field for material surface characterization<sup>1</sup>. The 3Flex has become a crucial tool for providing high resolution adsorption and desorption isotherms to advance and validate fundamental understanding into development of methodologies and process improvements.

### Extend and Increase Your Knowledge

3Flex permits you to optimize experimental parameters to gain greater understanding of your material. This is the only available 3-port surface characterization system with the ability to analyze a sample with 3 separate probe gases simultaneously, one on each analysis port, within a single run.

### Extend Your Range of Study

Go beyond micropore and extend your range of resolution to the ultra-microporous level. The advanced engineered design of the 3Flex permits you to acquire accurate results with a resolution to  $10^{-6}$  mmHg.

### Optimize Your Process

With 3Flex you gain valuable data to validate your theories and rationalize the design and synthesis of MOFs, zeolites, activated carbons and other products. Utilize the high throughput results of the 3-port mesopore and micropore design of the 3Flex to gain rapid understanding of restrictions or boundaries that may influence or impede your process optimization.

*97% of customers are likely to recommend Micromeritics 3Flex Solution.*

An independent study by TechValidate  
TVID:645-C46-D86

## Metal Organic Frameworks and Porous Organic Polymers

Empowering the Study of Energy Storage and Gas Separations by MOFs and POPs

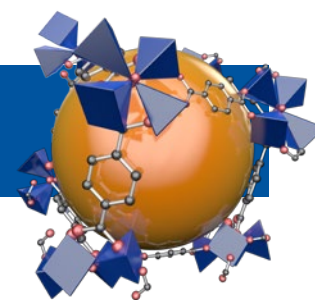

**Investigate the influence of Hydrogen adsorption enthalpy.** 3Flex has the ability to expediently switch from Physisorption to Chemisorption permitting investigation for enthalpy tied to ligand influence.

**Determine the influencing relationship of surface area, pore volume and substrate/analyte interactions for uptake, capacity, and release evaluations.**

3Flex is the only instrument capable of utilizing three gas probes of different

types to be used simultaneously in a analysis run, one probe gas on each of the three independent analysis ports.

**Evaluate optimal small pore size as a strategy to enhance hydrogen-framework interactions.**

Superior gas management and temperature control permits accurate and precise micropore and ultra-micropore (<0.7 nm) measurements.

**Confirm BBR (build block replacement) functional changes and their effects on performance.** MicroActive™ Data Software permits you to graphically capture the desired range of isotherm data using interactive, movable calculation bars. MicroActive enables you to export or report your findings in mmol/g.

## Energizing the understanding for strategy and synthesis in zeolite design

**Quantitatively determine the number of surface active sites for catalytic potential.**

Provide data related to monolayer uptake, metal area, dispersion and active metal area of heterogeneous catalysts. The advanced flexibility of the 3Flex lets you quickly change from Physisorption analysis to Chemisorption analysis in minutes to permit full characterization in one instrument

**Determine if zeolite processing has resulted in loss of structure or degradation.**

The advanced architecture of the 3Flex provides industry leading micropore resolution and may provide complimentary information along with X-Ray diffraction to resolve minor structural defects due to processing.

**Obtain valuable insight for pore architecture to gain greater understanding of transport, diffusion rates and selectivity.**

The advanced design of the 3Flex provides industry leading resolution and accuracy.

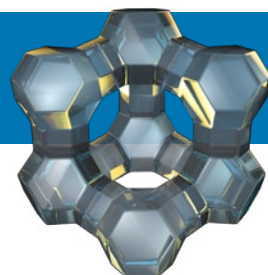

## Gain valuable data for improving activated carbon adsorbent and catalyst performance.

**Determine adsorption dynamics in regard to resident time for performance in fixed bed and flow through systems.**

Acquire valuable data for greater understanding of the influence of surface area and pore volume and pore size distribution on performance.

**Gain valuable insight of structural and chemical heterogeneity influence on adsorption dynamics.**

Superior gas management, hard seal valves and metal seals along with precise temperature control permit accurate and precise micropore measurements.

**Evaluate temperature and chemical deactivation processes in regard to porosity and surface activity.** Accurate temperature and gas control ensure repeatable analytical data sample to sample, batch to batch.

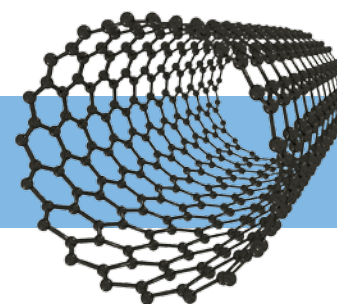

## Advancements in Performance and Technology



- Three configurable analysis ports adapt to the specific needs of your workflow
- Provides superior mesopore/micropore, physisorption, or chemisorption analyses. Ports can be configured for krypton analysis of low surface area materials
- Optional heated vapor sorption capability
- Sequence physisorption and chemisorption experiments
- Ultra-clean manifold design feature hard-seals valves and metal seals to provide high chemical resistivity, ease of evacuation, and lowest outgassing rate in the industry
- P<sub>0</sub> port with dedicated pressure transducer allows continuous monitoring of saturation pressure
- Isotherm data collection begins in the 10<sup>-6</sup> torr range (10<sup>-9</sup> relative pressure range for N<sub>2</sub>)
- MicroActive™ Data Reduction software provides powerful yet intuitive data analysis
- Advanced dosing method permits user to combine pressure and volume increments
- Small footprint conserves valuable bench space
- Analyze a sample with three separate adsorbent gases simultaneously, one at each port in a single analysis

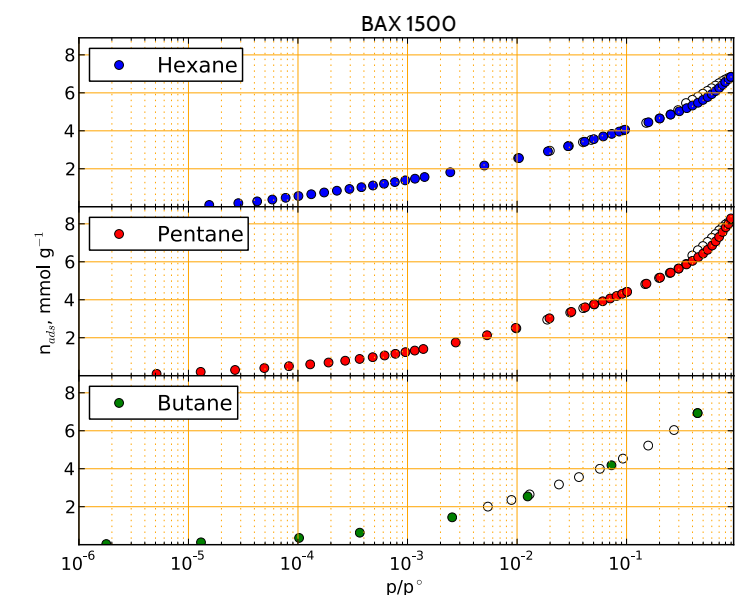
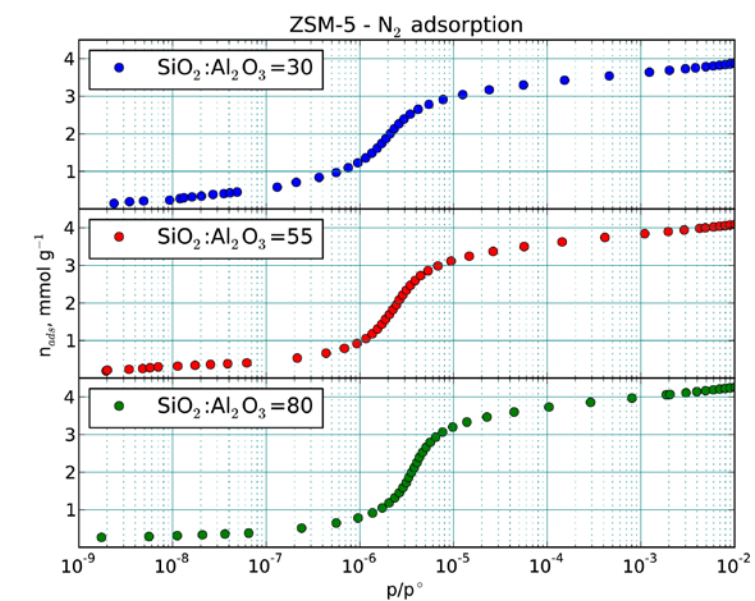
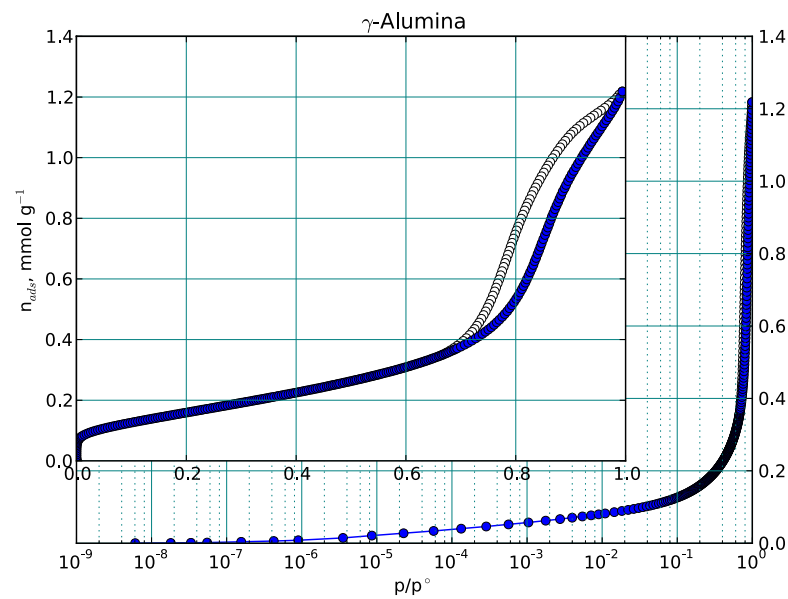

The new manifold design and embedded control provides an ultra-stable environment for pressure and temperature measurements. In addition to hardware advancements, the 3Flex contains several software advancements including a new advanced dosing method that allows you to mix both pressure and volume increments.

The 3Flex includes an extensive library of fluid properties of fixed gases and commonly used vapors. Isotherm data are easily collected using hydrocarbons as the adsorptive.

## Data Reduction and Control Software

- Interaction with adsorption data is direct. By simply moving the calculation bars, the user is immediately updated with new textural properties
- Click-and-drag bars slide to select the calculation range, minimizing the use of dialog boxes and tunneling of dialogs to specify calculation parameters
- User-selectable data ranges through the graphic interface allow direct modeling for BET, BJH, t-Plot, Langmuir, DFT interpretation, and much more. The MicroActive isotherm analysis suite provides an extensive selection of NLDFT models for calculating pore size distributions
- Report Options editor allows you to define reports with on-screen previews
- Includes Python programming language for user defined reports
- Improved ability to overlay up to 25 files, including mercury intrusion data with a file add-and-subtract feature

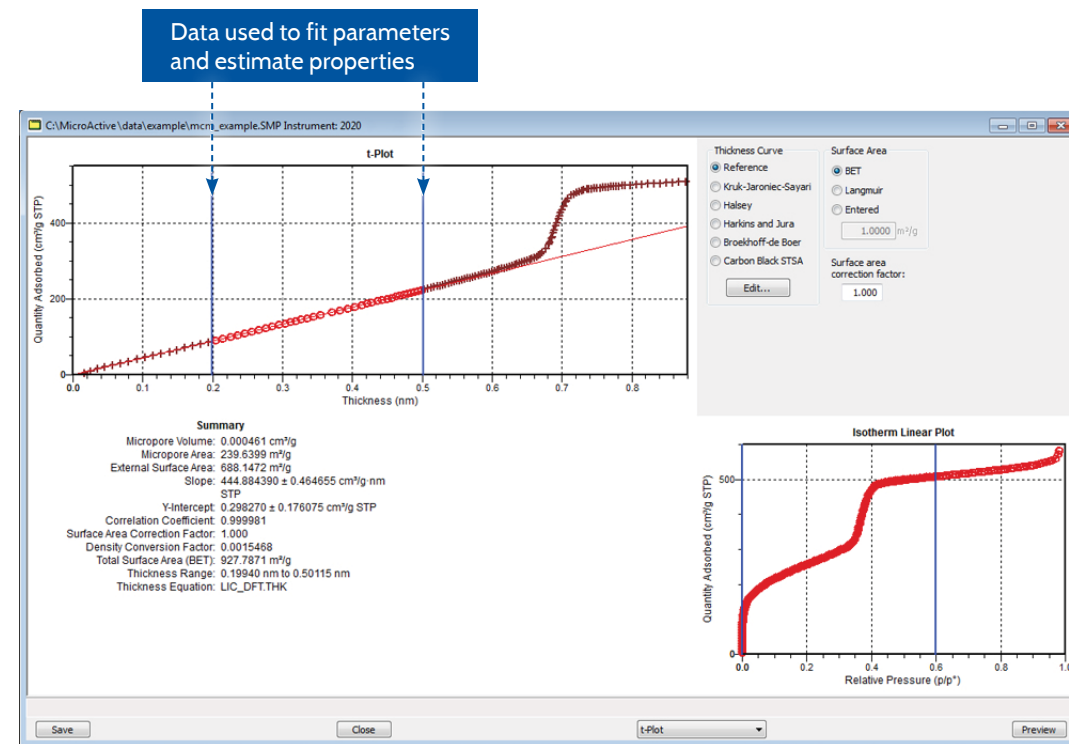

t-Plot analysis of N2 at 77K on MCM-41 silica. The t-Plot calculation shows this is not a microporous material despite the large gas capacity.

- ### 3Flex Interactive Reports Include:
- Isotherm
  - BET Surface Area
  - Langmuir Surface Area
  - t-Plot
  - Alpha-S Method
  - BJH Adsorption and Desorption
  - Dollimore-Heal Adsorption and Desorption
  - Horvath-Kawazoe
  - MP-Method
  - DFT Pore Size and Surface Energy
  - Dubinin-Radushkevich
  - Dubinin-Astakhov
  - User-Defined Reports (5)

*"[3Flex has] excellent quality and high sample through-put with reliability and accuracy."*

Matthew Hall  
Laboratory Director  
The University of Nottingham

An independent study by TechValidate  
TVID:F6A-C04-46D

### NLDFT Dual Isotherm Deconvolution and Pore Size Distribution

The NLDFT Advanced PSD, Dual DFT modeling allows the user to combine the information gathered from nitrogen and carbon dioxide isotherms to deliver a full pore size distribution on materials (such as carbon slit pores) where pores of molecular sizes are present. The range of pore size analysis in this method is extended to smaller pore sizes compared to the standard nitrogen analysis. This is due to the fact that CO<sub>2</sub> can access ultra micropores that are not accessible to N<sub>2</sub> at cryogenic temperatures because of diffusion limitations.

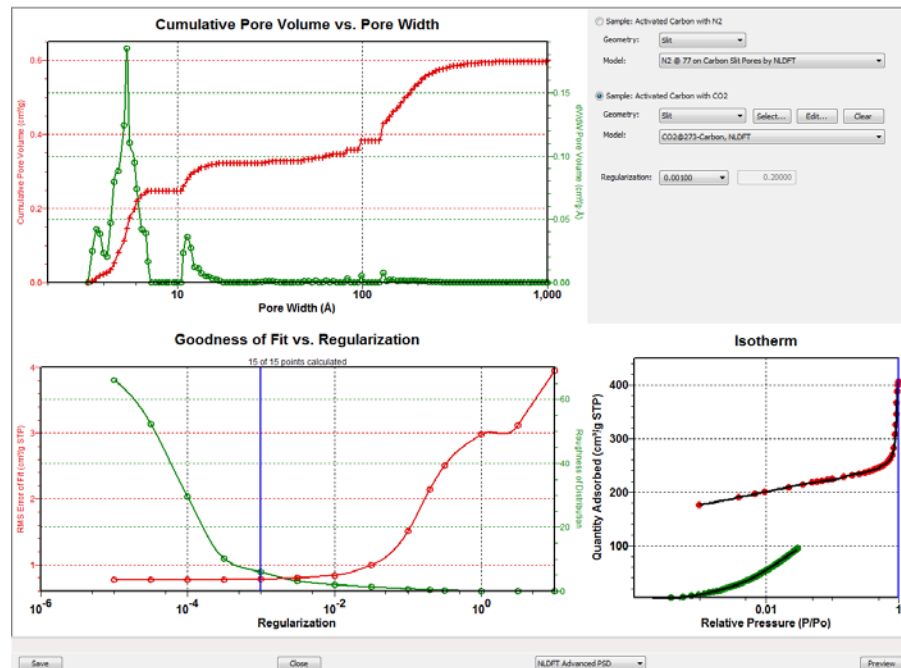

This advanced NLDFT method allows you to determine the pore size distribution of your sample using two isotherms. In this example, CO<sub>2</sub> adsorption (green) at 77 K and N<sub>2</sub> (red) are used to calculate a single pore-size distribution. You do not have to cut and paste distributions from CO<sub>2</sub> and nitrogen—a single distribution is determined using both isotherms.

### Mercury Porosimetry/Gas Adsorption Overlay

MicroActive for the 3Flex includes a powerful utility that permits you to overlay pore size distributions from mercury porosimetry with those from gas adsorption. This new import function allows you to rapidly view micropore, mesopore, and macropore distributions in a single application.

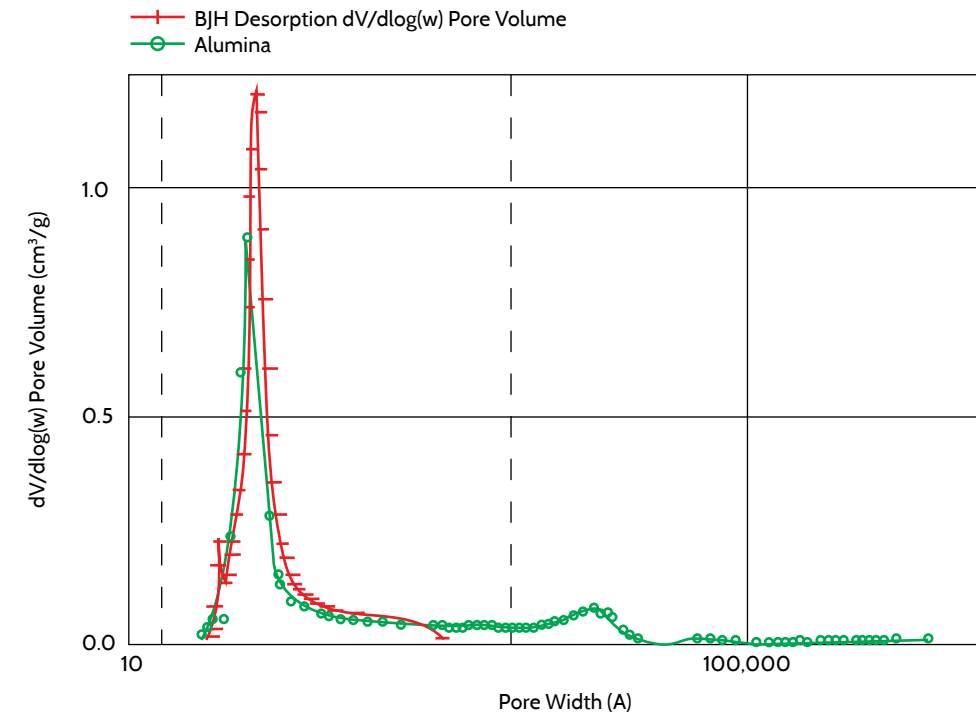

Overlay of BJH desorption and mercury intrusion log differential pore size distributions for alumina pellets



*“The equipment is used by many researchers and runs almost 24/7. It enhanced both our throughput, as well as the resolution that we could achieve in measuring zeolites.”*

Ive Hermans  
Principal Investigator (PI)  
The University of Wisconsin-Madison

# Catalyst Characterization: The 3Flex Chemisorption Option

With the chemisorption option, the 3Flex is configured to perform chemical adsorption analyses that enable the researcher to obtain valuable information about the physical or chemical properties of catalysts, catalyst supports, and a variety of other materials.

This versatile instrument permits you to change from chemisorption to physisorption analysis in minutes.



- VCR seals provide higher levels of system cleanliness, low outgas rates, and base pressures. The result is accurate low-pressure chemisorption isotherms and the ability to measure oxygen-sensitive materials

- Standard high-precision mass flow controller provides extremely accurate, programmable gas control

- High-temperature furnace (up to 1100°C) provides quick and accurate ramp rates to desired temperature with precise temperature control and repeatability ( $\pm 1^\circ\text{C}$ )

- Up to a total of sixteen\* gas inlets allow multiple probe gases to be investigated maximizing efficiency and range of applications

- Superior temperature control maintains accuracy and repeatability in monotonic isotherms

- Design permits transition from chemisorption to micropore physisorption within minutes

- New high-temperature, precision quartz cell improves accuracy and sensitivity for challenging analyses

- Heated vapor can also be used as the adsorptive for chemical adsorption analyses

- Kalrez, Viton, or Buna O-rings provide maximum flexibility for chemical compatibility

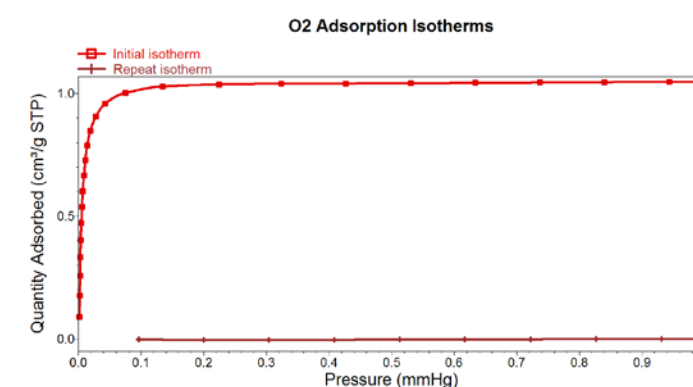
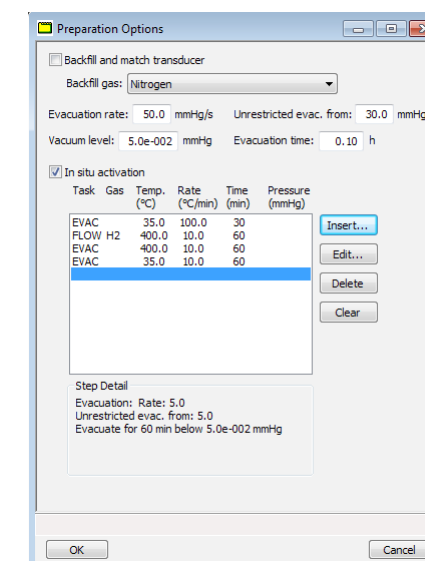
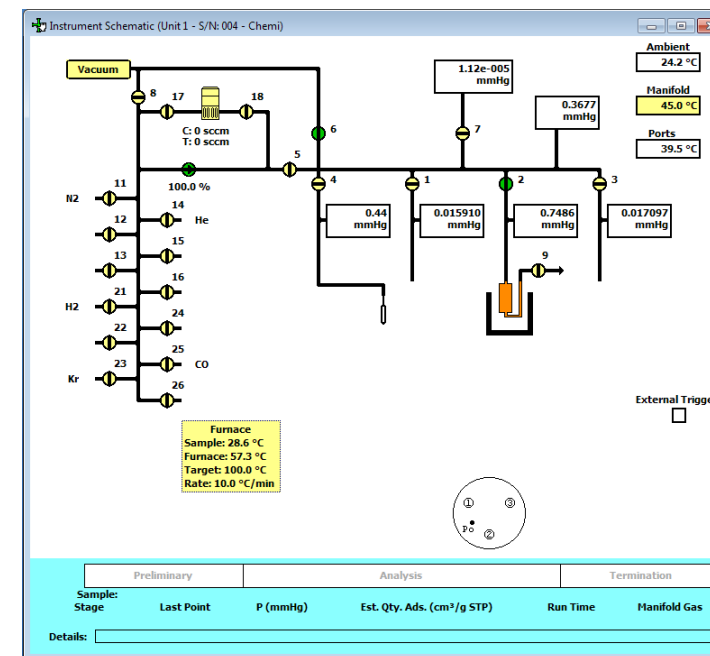

## Superior Hardware Versatility

Up to sixteen-inlet\* gas manifold is standard with the chemisorption capability. Flow control during sample activation utilizes a mass flow controller (MFC) for precise and repeatable sample preparation. The MFC is included in the standard chemisorption hardware.

## In situ Sample Preparation and Activation

In situ preparation and activation provide a fully automated method that does not require user intervention and fully integrates activation and analysis into one simple-to-use application. Flexible pre-treatment options allow for reduction, oxidation, evacuation, and purging.

## Sample Analysis Options

- Gas selection
- Free space measured at both ambient and analysis temperature
- Dosing options added to the pressure table give you the ability to change the pressure increment, volume dose increment, and equilibrium interval time between data points
- Dosing from gas inlets or vapor source
- Automatically repeat isotherm to analyze reversible sorption

\*Only available optional level 2 TCD

\*Only available optional level 2 TCD

# 3Flex Chemi-TCD Option

## Perform High Resolution TPR, TPO, and TPD Experiments

Micromeritics 3Flex, the industry's most highly recognized and preferred instrument for physisorption and chemisorption<sup>1</sup>, has been made even more powerful.

With the addition of the integral thermal conductivity detector, dynamic chemisorption analyses are available to the user providing the ability to perform temperature programmed reduction (TPR), oxidation (TPO), desorption (TPD), and reactions (TPRx).

The TCD option provides the capability to investigate temperature dependence of specific adsorption or desorption process profiles for catalyst and adsorbents, as well as pulse chemisorption in one very capable instrument.



## 3Flex Chemi-TCD Available Configurations:

### Level 1

Includes injection port, cold trap, and new analysis protocols in MicroActive to support dynamic chemisorption analyses.

### Level 2

Pulse chemisorption adds increased precision, repeatability, and reproducibility by the addition of an injector loop valve with two loop options in addition to four gas inlets, a restrictor for flow control and an industry exclusive; local temperature measurement/control at loop injection

## Included Features of the 3Flex TCD Option:

- Time, temperature, and TCD signal are recorded via the newly enhanced MicroActive interactive software. In addition to data collection a full suite of signal processing tools are available to transform raw data to sample property information. These tools include: peak integration, peak deconvolution (curve fitting), and calculation of active surface area, crystallite size, and dispersion.
- *Industry exclusive*, localized loop valve temperature measurement and control improves precision, signal detectability and repeatability of the precision, detectability, and repeatability in the TCD signal.
- Full versatility; change from chemisorption experiments to physisorption analysis in minutes.

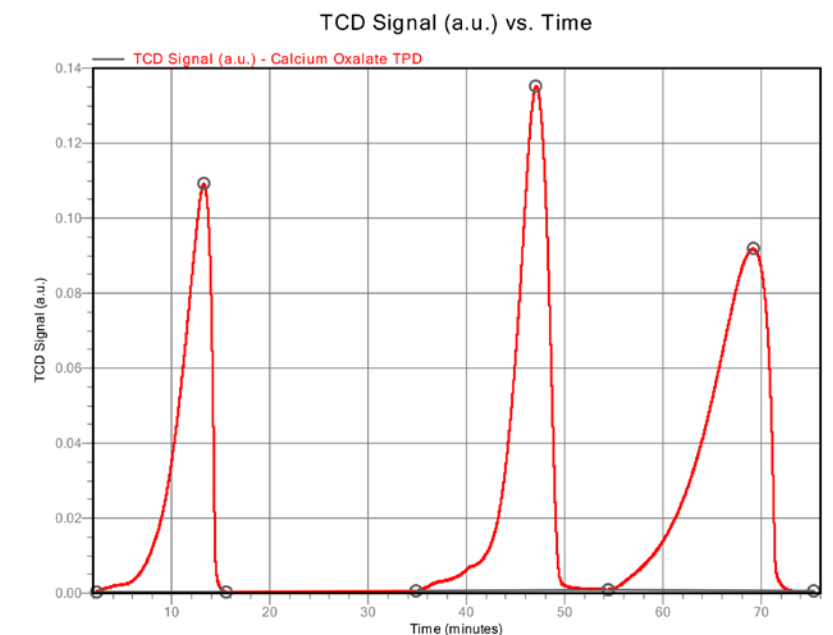
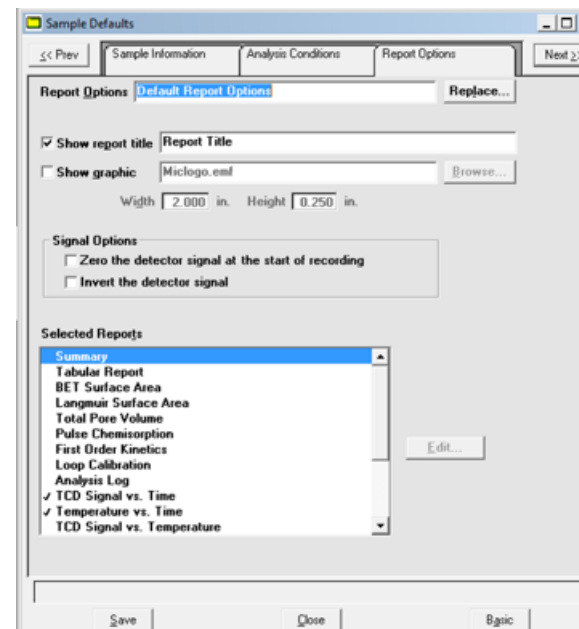

<sup>1</sup>Study conducted by independent firm, Tech Validate<sup>®</sup>, TVID 784-C23-98E, 2015

## Accessories

### Chiller Dewar Liquid Recirculation System

Micromeritics' Chiller Dewar is a closed loop recirculating system that utilizes a high surface area copper coil to provide excellent heat transfer between the dewar and the recirculating liquids. Temperature control is provided through an external recirculating bath or chiller bath which are supplied as accessory items.

Temperature Range	-50 °C to 200 °C
Temperature Stability	±0.01 °C



### ISO Controller Sub-Ambient, Thermoelectric Cooled Dewar

Micromeritics' ISO Controller utilizes thermoelectric cooling based on the Peltier principle. The unit is designed to maintain a constant temperature between -5 °C and 80 °C when using CO<sub>2</sub>, N<sub>2</sub>, and other gases for adsorption analysis. The device rapidly cools and efficiently maintains temperature with minimal electrical current required.

The dewar section is placed on the instrument dewar elevator and then raised into position for analysis.

Temperature Range	-5 °C to 80 °C (lab temp <27 °C)
Cooling Capacity	Approx. 80W at 0 °C, 120W at 25 °C
Minimum Controllable Resolution	0.1 °C
Temperature Stability	±0.1 °C



### Cryostat I Single-Stage Cryogenic Refrigerator Based on the Gifford-McMahon Principle

The Micromeritics Cryostat I is a closed-cycle cryocooler based on the Gifford-McMahon (GM) refrigeration principle. It uses helium gas from a helium compressor to generate cryogenic temperatures.

The Cryostat I eliminates the need for liquid nitrogen and can obtain temperatures below the 77 K of liquid nitrogen.

Temperature Range	25 to 350 K
Temperature Stability	±0.005 K
Nitrogen Reservoir	closed-cycle helium
Cool Down Time to Stated Minimum from Ambient	60 minutes

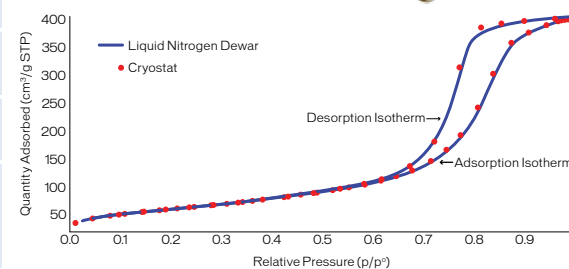

## Specifications

	3Flex Physisorption Only	3Flex Chemisorption
<b>Analysis</b>		
Analysis Range	1.3 x 10 <sup>-9</sup> to 1.0 P/P <sub>0</sub>	1 x 10 <sup>-6</sup> to 900 torr
Available Micropore Ports	up to 3	up to 3, one port dual purpose chemisorption and physisorption
Dosing and Evacuation Control	Proprietary Servo	Proprietary Servo
Roughing Pump	4 stage diaphragm	4 stage diaphragm
Krypton Analysis	Standard 1 port, optional up to 3 ports	Standard 2 or 3 ports

### Analysis Gas Per Sample

Ability to use up to 3 gases concurrently, one probe gas on each port

### Minimum Measurable Surface Area

Standard	0.01 m <sup>2</sup> /g	0.01 m <sup>2</sup> /g
Krypton	0.0005 m <sup>2</sup> /g	0.0005 m <sup>2</sup> /g

### Instrument Control and Features

Temperature Control	45 °C, ±0.05 °C with 3 strategically placed RTDs	45 °C, ±0.05 °C with 3 strategically placed RTDs
Adsorptive Gas Inlets	6	12 standard; optional up to 16
Vapor Sorption Option	Standard ports 1 and 2, optional heated	Standard ports 1 and 2, optional heated
Furnace (chemisorption model only)	N/A	Programmable- 0.1-50 °C/minute 50 °C/min to 600 °C 20 °C/min from 600 to 800 °C 10 °C/min from 800 to 1100 °C
Mass Flow Controller (chemisorption model only)	N/A	Standard, flow up to 200 cm <sup>3</sup> /m, ±1% of set point
TCD w/cold trap (chemisorption model only)	N/A	Optional two levels of available performance
Standard External Dedicated Port	N/A	Heated port for connection of external detectors including an available Cirrus™ Quadrapole Mass Spec
Degas	3 in situ, 6 additional with SmartVac Prep	3 in situ, 6 additional with SmartVac Prep
A/D data acquisition	29 bit (effective 25)	29 bit (effective 25)
Pressure Transducer System	up to 12	up to 12
Transducer Accuracy	1000 torr 0.12% reading 10 torr 0.12% reading 0.1 torr 0.15% reading	1000 torr 0.12% reading 10 torr 0.12% reading 0.1 torr 0.15% reading

### Cryogen

Cryogen Dewar	3.2 L, greater than 70 hrs virtually unlimited with refill during analysis	3.2 L, greater than 70 hrs virtually unlimited with refill during analysis
Cryogen Free Space Control	Isothermal Jacket	Isothermal Jacket

### Reports

Advanced Modeling	GAB, Sips, Toth, dissociative Langmuir, Redlich-Peterson
Instrument Operation Dashboard	Dashboard permits real-time monitoring of critical parameters

### Minimized Bench Space Footprint

Height	112 cm	112 cm
Width	57.2 cm	57.2 cm
Depth	61 cm	61 cm

Provided specifications were valid as taken from available documents at time of publication. These specifications may change without notice and are only provided as a general reference.





## Micromeritics Instrument Corporation

4356 Communications Drive, Norcross, GA 30093 USA

To request a quote or additional product information, visit

[micromeritics.com](http://micromeritics.com)

Contact your local Micromeritics sales representative  
or our Customer Service Department at

**770-662-3636**

